

# JFX200i Specifications



## FEATURES

- Ideal size and performance for rigorous all-purpose use
- 12-inch LF driver for best vocal and music reproduction
- Wave Guide Plate optimizes HF voicing in for near field applications
- Asymmetric enclosure provides multiple mounting angles
- Pole mount & fly track plus Omnimount® Series 120.0 compatible mounting points
- User-selectable, single-amplified and bi-amplified operating modes

## DESCRIPTION

The JFX200i full-range loudspeaker is a multi-functional design, adding considerably to its value as a full-range loudspeaker. It is an ideal size and output for wide range of programs. Combining high output capability with natural reproduction, it is specifically outfitted to serve in a variety of both portable and permanent applications.

The asymmetric enclosure provides typical angles needed for ceiling and wall mounting as well as for stage monitor operation. For portable use, provisions include a pole mount cup, top/bottom fly track for rigging, and handles integral to the enclosure that facilitate handling and transport. For permanent installation, enclosure hardware includes mounting points for an Omnimount® Series 120.0 or similar bracket and fly track for suspension.

The JFX200i is particularly suitable as a near field main loudspeaker, a fill/delay element in larger systems, for surround sound installations, and as voice and F/X reinforcement in themed attractions. Its conical projection is ideal for near field or other typically "low Q" applications. While the JFX200i is well suited as is for many applications, the addition of a SBX220 subwoofer, especially designed to complement the JFXi Series, expands the low frequency capabilities for more demanding applications. These include houses of worship, theaters, and band PA.

Six year warranty.

## 2-WAY FULL-RANGE 12-inch LF, 90° Conical

See **NOTES TABULAR DATA** for details

### CONFIGURATION

#### Subsystem

	<b>Transducer</b>	<b>Loading</b>
LF	1x 12 in cone	Vented
HF	1x 1.4 in exit, 3 in voice coil compression driver	Wave Guide Plate™

#### Operating Mode

	<b>Amplifier Channels</b>	<b>External Signal Processing</b>
Single-amp	LF/ HF	DSP
Bi-amp	LF, HF	DSP w/2-way filters

### PERFORMANCE<sup>1</sup>

**Operating Range** 68 Hz to 20 kHz

#### Nominal Beamwidth

Conical 90°

#### Axial Sensitivity (whole space SPL)

LF/HF	96 dB	68 Hz to 20 kHz
LF	x dB	68 Hz to x Hz
HF	x dB	x Hz to 20 kHz

#### Input Impedance (ohms)

	<b>Nominal</b>	<b>Minimum</b>
LF/HF	8	5.7 @ 200 Hz
LF	8	x @ 165 Hz
HF	8	x @ 510 Hz

#### High Pass Filter

High Pass =>40 Hz, 24 dB/octave Butterworth

#### Accelerated Life Test<sup>2</sup>

LF/HF	63 V	500 W @ 8 ohm
LF	63 V	500 W @ 8 ohm
HF	x V	200 W @ 8 ohm

#### Calculated Axial Output Limit (whole space SPL)

	<b>Average</b>	<b>Peak</b>
LF/HF	123 dB	129 dB
LF	x dB	x dB
HF	x dB	x dB

### ORDERING DATA

<b>Description</b>	<b>Part Number</b>
JFX200i 2-Way Full-Range Loudspeaker Black	0013462
<b>Optional Accessories</b>	
Fly Clip with Ring	0001386
Eyebolt/Forged Shoulder (3/8-16 x 1.25 in)	104001

<sup>1</sup> To achieve specified performance, the listed external signal processing with EAW-provided settings is required.

<sup>2</sup> For recommendations to select power amplifier size refer to: "HOW MUCH AMPLIFIER POWER DO I NEED?" on the EAW web site.

# JFX200i Specifications

## ENCLOSURE

Material	Baltic birch plywood
Finish	Wear resistant textured black paint
Grille	Powder-coated perforated steel

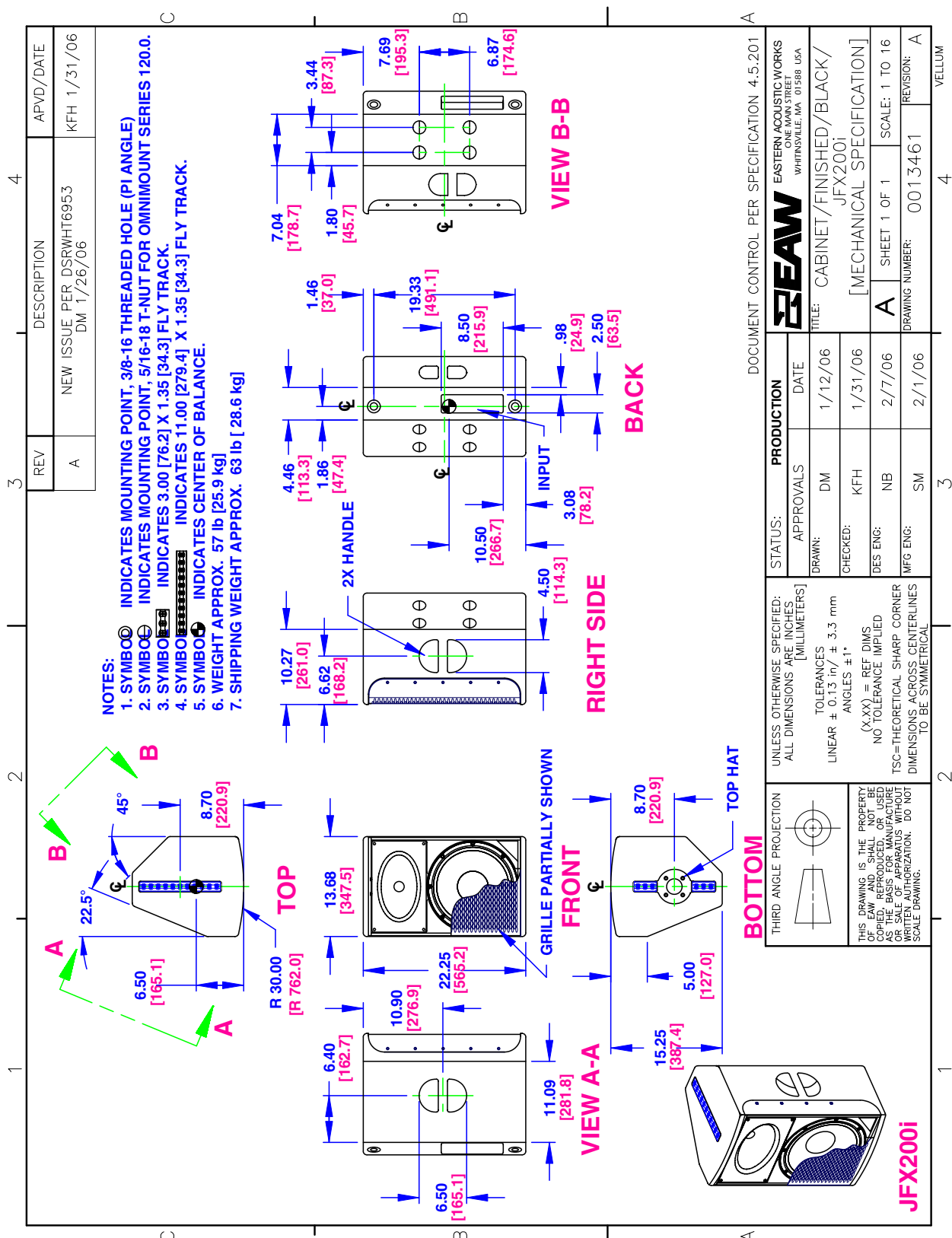

NOTE: This drawing has been reduced. Do not scale.



# JFX200i Specifications

## PERFORMANCE DATA

See **NOTES GRAPHIC DATA** for details

### Frequency Response: Processed Bi-amplified

LF = green, HF = black, Complete = blue

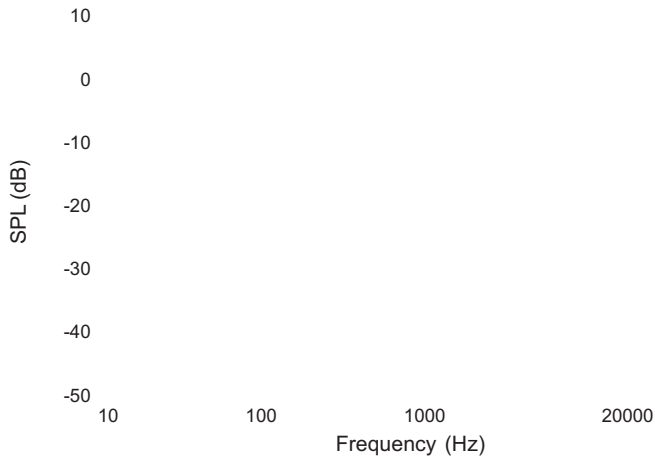

### Frequency Response: Processed Single-amplified

Complete = blue

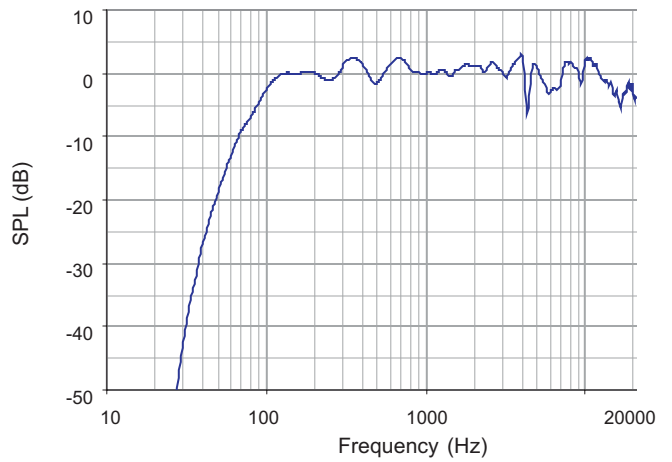

### Frequency Response: Unprocessed

LF = green, HF = black, Single-amp = blue

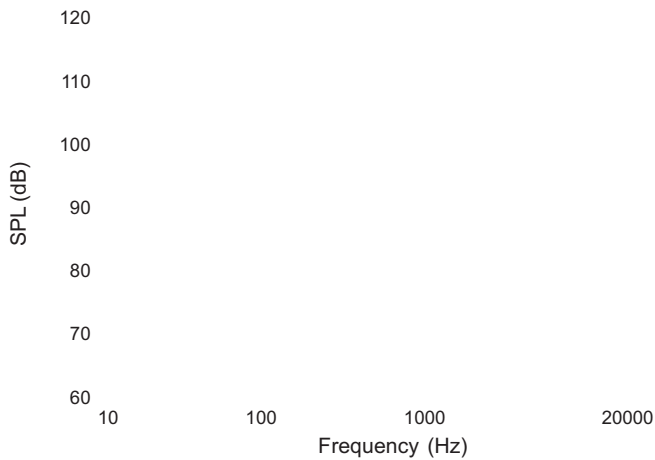

### Frequency Response: Digital Signal Processor

LF = green, HF = black, Single-amp = blue

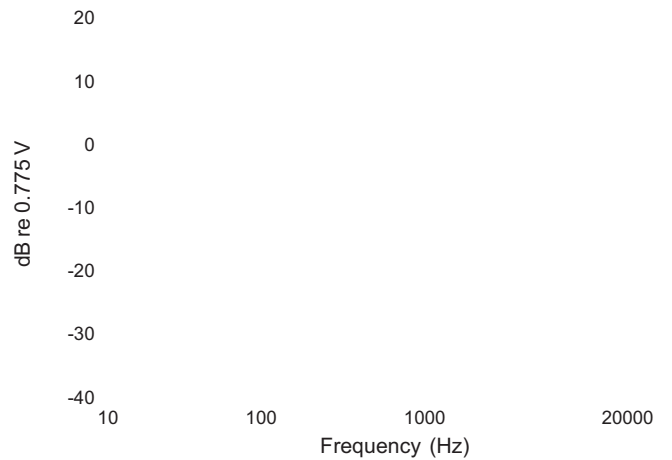

### Impedance Magnitude

LF = green, HF = black, Single-amp = blue

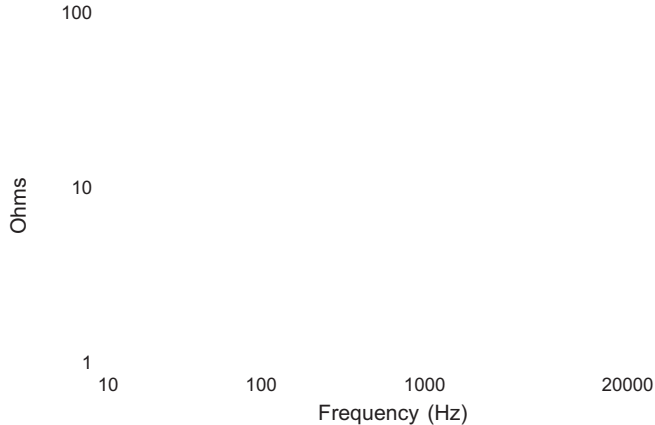

### Beamwidth (-6 dB SPL Points)

Horizontal = orange Vertical = black

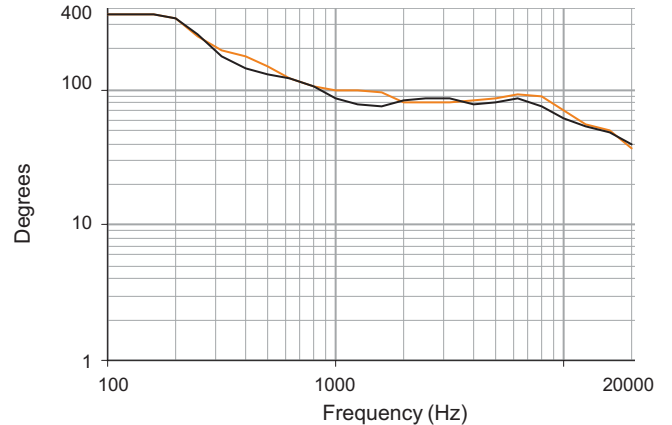

# JFX200i Specifications

## HORIZONTAL POLAR DATA (Gridlines: 6 dB axial / 15 degree radial)

See **NOTES GRAPHIC DATA** for details

100 Hz  
125 Hz  
160 Hz  
200 Hz

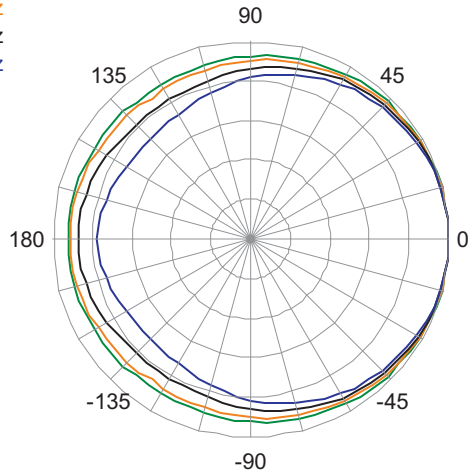

1600 Hz  
2000 Hz  
2500 Hz  
3150 Hz

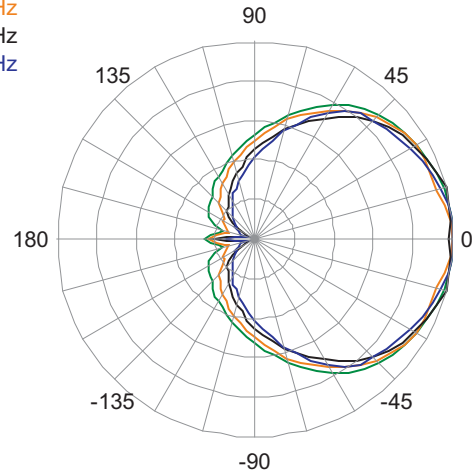

250 Hz  
315 Hz  
400 Hz  
500 Hz

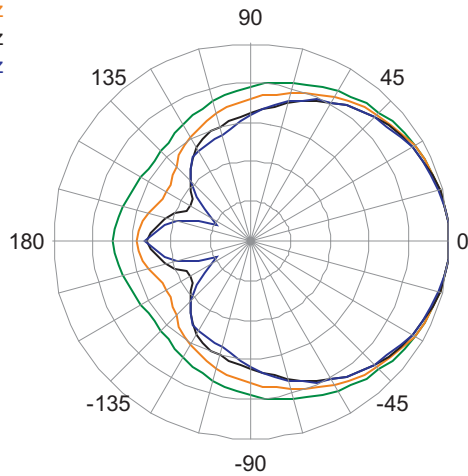

4000 Hz  
5000 Hz  
6300 Hz  
8000 Hz

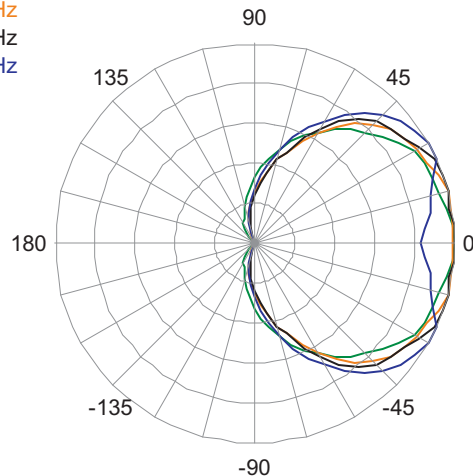

630 Hz  
800 Hz  
1000 Hz  
1250 Hz

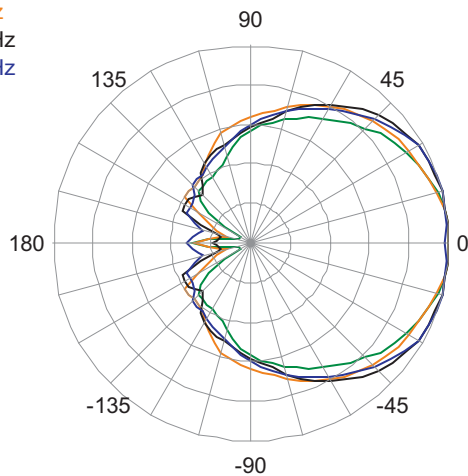

10000 Hz  
12000 Hz  
16000 Hz

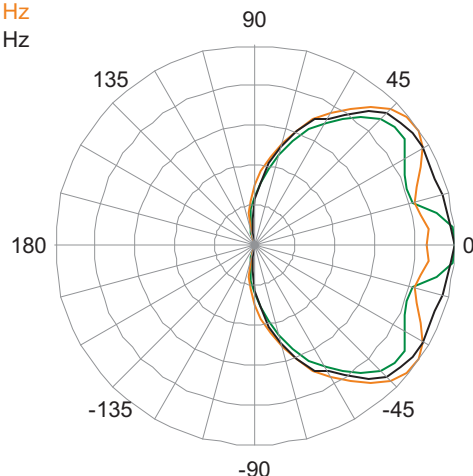

# JFX200i Specifications

## VERTICAL POLAR DATA (Gridlines: 6 dB axial / 15 degree radial)

See **NOTES GRAPHIC DATA** for details

100 Hz  
125 Hz  
160 Hz  
200 Hz

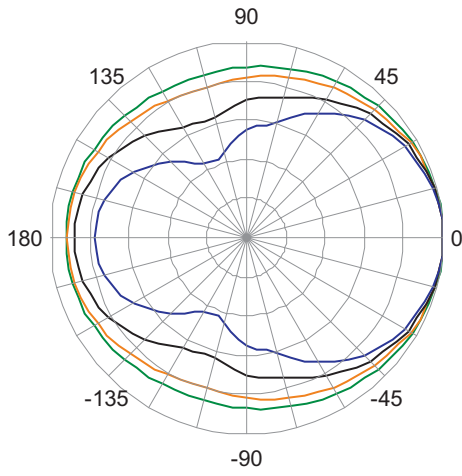

1600 Hz  
2000 Hz  
2500 Hz  
3150 Hz

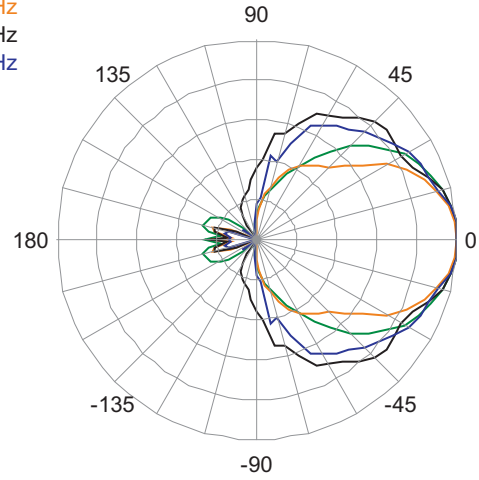

250 Hz  
315 Hz  
400 Hz  
500 Hz

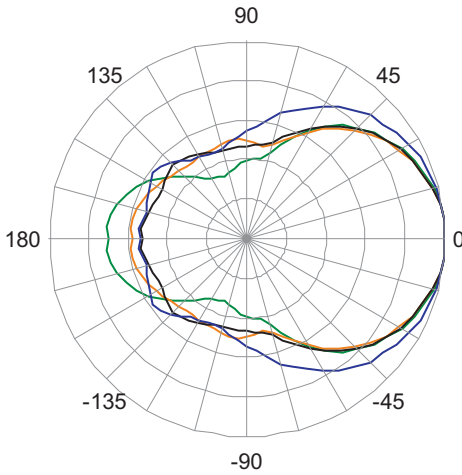

4000 Hz  
5000 Hz  
6300 Hz  
8000 Hz

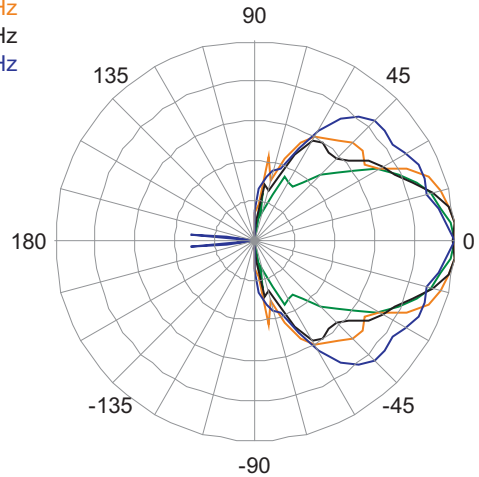

630 Hz  
800 Hz  
1000 Hz  
1250 Hz

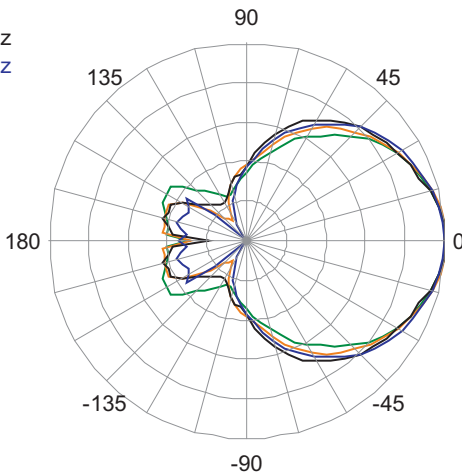

10000 Hz  
12000 Hz  
16000 Hz

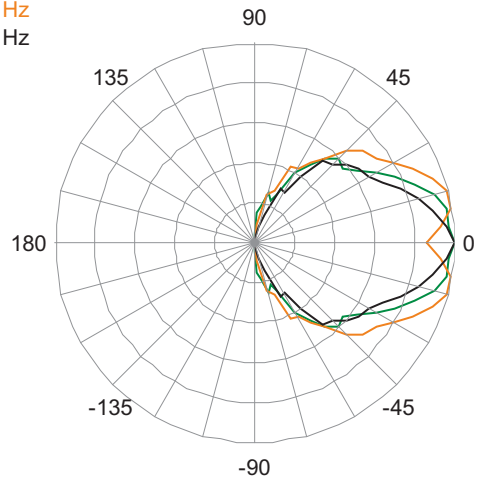

# JFX200i Specifications

## INPUT PANEL

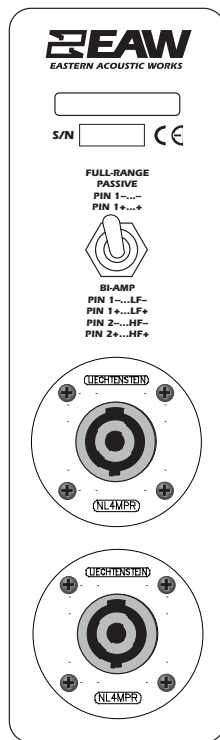

## SIGNAL DIAGRAM

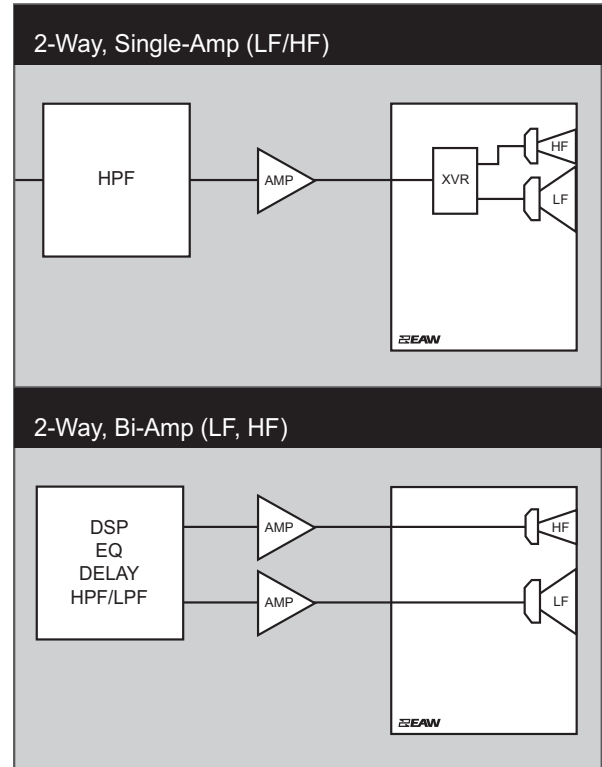

## LEGEND

<b>DSP:</b>	User-supplied Digital Signal Processor.
<b>HPF:</b>	High Pass Filter for crossover or Recommended High Pass Filter.
<b>LPF:</b>	Low Pass Filter for crossover.
<b>LF/MF/HF:</b>	Low Frequency / Mid Frequency / High Frequency.
<b>AMP:</b>	User-supplied Power Amplifier.
<b>XVR:</b>	Passive LPFs, HPFs, and EQ integral to the loudspeaker.

## NOTES

### TABULAR DATA

- Measurement/Data Processing Systems:** Primary - FChart: proprietary EAW software; Secondary - Brüel & Kjær 2012.
- Microphone Systems:** Earthworks M30; Brüel & Kjær 4133
- Measurements:** Dual channel FFT; length: 32 768 samples; sample rate: 48 kHz; logarithmic sine wave sweep.
- Measurement System Qualification** (includes all uncertainties): SPL: accuracy +/-0.2 dB @ 1 kHz, precision +/-0.5 dB 20 Hz to 20 kHz, resolution 0.05 dB; Frequency: accuracy +/-1 %, precision +/-0.1 Hz, resolution the larger of 1.5 Hz or 1/48 octave; Time: accuracy +/-10.4 µs, precision +/-0.5 µs, resolution 10.4 µs; Angular: accuracy +/-1°, precision +/-0.5°, resolution 0.5°.
- Environment:** Measurements time-windowed and processed to eliminate room effects, approximating an anechoic environment. Data processed as anechoic or fractional space, as noted.
- Measurement Distance:** 7.46 m. Acoustic responses represent complex summation of the subsystems at 20 m. SPL is referenced to other distances using the Inverse Square Law.
- Enclosure Orientation:** For beamwidth and polar specifications, as shown in Mechanical Specification drawing.
- Volts:** Measured rms value of the test signal.
- Watts:** Per audio industry practice, "loudspeaker watts" are calculated as voltage squared divided by rated nominal impedance. Thus, these are not True Watt units of energy as defined by International Standard.
- SPL:** (Sound Pressure Level) Equivalent to the average level of a signal referenced to 0 dB SPL = 20 microPascals.
- Subsystem:** This lists the transducer(s) and their acoustic loading for each passband. Sub = Subwoofer, LF = Low Frequency, MF = Mid Frequency, HF = High Frequency.
- Operating Mode:** User selectable configurations. Between system elements, a comma (,) = separate amplifier channels; a slash (/) = single amplifier channel. DSP = Digital Signal Processor. IMPORTANT: To achieve the specified performance, the listed external signal processing must be used with EAW-provided settings.
- Operating Range:** Range where the processed Frequency Response stays within -10 dB SPL of the power averaged SPL within this range; measured on the geometric axis. Narrow band dips are accepted.
- Nominal Beamwidth:** Design angle for the -6 dB SPL points, referenced to 0 dB SPL as the highest level.
- Axial Sensitivity:** Power averaged SPL over the Operating Range with an input voltage that would produce 1 W at the nominal impedance; measured with no external processing on the geometric axis, referenced to 1 m.
- Nominal Impedance:** Selected 4, 8, or 16 ohm resistance such that the minimum impedance point is no more than 20% below this resistance over the Operating Range.
- Accelerated Life Test:** Maximum test input voltage applied with an EIA-426B defined spectrum; measured with recommended signal processing and Recommended Protection Filter.
- Calculated Axial Output Limit:** Highest average and peak SPLs possible during the Accelerated Life Test. The Peak SPL represents the 2:1 (6 dB) crest factor of the Life Test signal.
- High Pass Filter:** This helps protect the loudspeaker from excessive input signal levels at frequencies below the Operating Range.

### GRAPHIC DATA

- Resolution:** To remove insignificant fine details, 1/12 octave cepstral smoothing was applied to acoustic frequency responses and 1/3 octave cepstral smoothing was applied to the beamwidth and impedance data. Other graphs are plotted using raw data.
- Frequency Responses:** Variation in acoustic output level with frequency for a constant input signal. Processed: normalized to 0 dB SPL. Unprocessed inputs: 2 V (4 ohm nominal impedance), 2.83 V (8 ohm nominal impedance), or 4 V (16 ohm nominal impedance) referenced to a distance of 1 m.
- Processor Response:** The variation in output level with frequency for a constant input signal of 0.775 V = 0 dB reference.
- Beamwidth:** Average angle for each 1/3 octave frequency band where, starting from the rear of the loudspeaker, the output first reaches -6 dB SPL referenced to 0 dB SPL as the highest level. This method means the output may drop below -6 dB SPL within the beamwidth angle.
- Impedance:** Variation in impedance magnitude, in ohms, with frequency without regard to voltage/current phase. This means the impedance values may not be used to calculate True Watts (see 9 above).
- Polar Data:** Horizontal and vertical polar responses for each 1/3 octave frequency band 100 Hz to 16 kHz or Operating Range.